



Item: _____
 Quantity: _____
 Project: _____

Royal Series

Models: RMG-12OB2 RMG-24OB2 RMG-24OB4 RMG-36OB2
 RMG-36OB4 RMG-48OB2 RMG-48OB4



RMG-36-OB2

Gas Type: Natural LP

Elevation (if above 2000 ft.): _____

Standard Features

- 11" high, Low Profile
- Full width, removable stainless steel crumb pan under open burners for easy cleaning
- Large 1½ gallon capacity stainless steel grease can
- Compact heavy gauge chassis for long life
- Stainless steel sides, front valve cover and ledge
- Double wall panels for cooler sides
- Stainless Steel "U" shaped burner every 12" rated at 30,000 BTU/hr
- Cast iron lift off head burners rated at 30,000 BTU/hr in the hot plate section
- 3/4" thick griddle plate with polished cooking surface
- Manual control for each burner
- 4" wide S/S grease trough with large drain opening for easy cleaning
- Stainless steel tubing for pilots
- 4" high adjustable heavy duty legs included

Options and Accessories

- 1" thick griddle plate
- Wok burner head with 10" diameter S/S ring
- Grooved griddle (specify width: _____")
- Chrome griddle plate
- Stainless Steel Equipment Stand
 - Knock Down All Welded
- Size
 - 24" 36" 48" 60" 72"
- 5" swivel casters (set of four - 2 locking)
- 5" swivel casters (set of six - 3 locking) (60" and 72" models)



2 YEAR LIMITED, PARTS AND LABOR WARRANTY

Manual Griddle/Hot Plate Combination

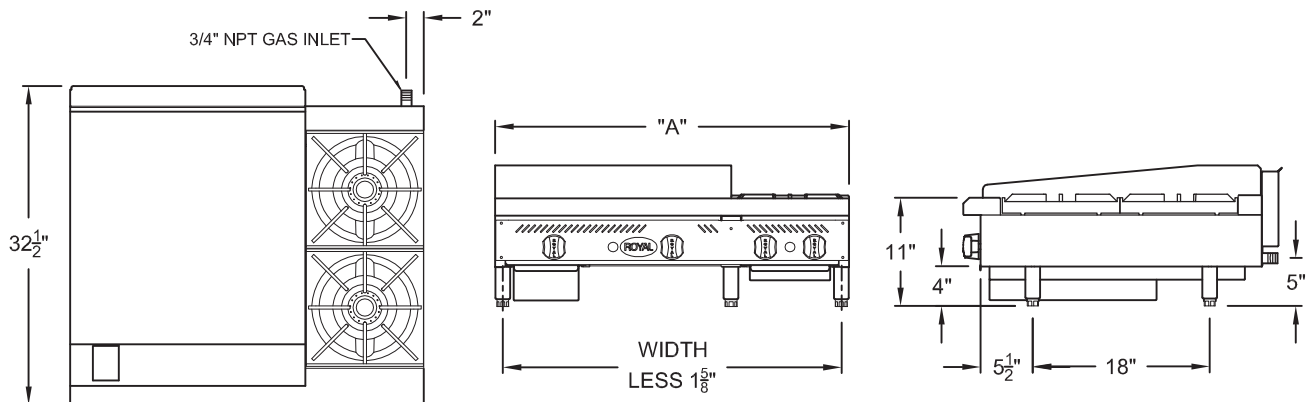

Model Number	Width (A)	Number of Burners	Total BTU	Ship Weight
RMG-12OB2	24"	1G/2OB	90,000	295 lbs.
RMG-24OB2	36"	2G/2OB	120,000	405 lbs.
RMG-24OB4	48"	2G/4OB	180,000	465 lbs.
RMG-36OB2	48"	3G/2OB	150,000	535 lbs.
RMG-36OB4	60"	3G/4OB	210,000	595 lbs.
RMG-48OB2	60"	4G/2OB	180,000	695 lbs.
RMG-48OB4	72"	4G/4OB	240,000	864 lbs.

Notes:

- Each burner is rated at 30,000 BTU/hr

Gas Connection:

3/4" NPT on the right hand rear of the appliance.

The pressure regulator (supplied) is to be connected by the installer.

Specify type of gas and altitude, if over 2,000 feet, when ordering.

Gas Pressure:

5" W.C.	Natural Gas
10" W.C.	Propane

Clearances:

	Combustible	Non-Combustible
Rear	4"	0"
Sides	15"	0"

Due to continuing product development to ensure best possible performance, these specifications are subject to change without prior notification.

Royal Range of California, Inc.
 3245 Corridor Dr. • Eastvale, CA 91752 • (800) 769-2414 • (951) 360-1600
 Fax: (951) 360-7500 • www.royalranges.com • sales@royalranges.com