



Item: _____

Quantity: _____

Project: _____

36" Gas Restaurant Range

36" Gas Restaurant Range

Models:	<input type="checkbox"/> RR-6	<input type="checkbox"/> RR-4G12	<input type="checkbox"/> RR-2G24	<input type="checkbox"/> RR-G36	<input type="checkbox"/> RR-4-36
	<input type="checkbox"/> RR-4RG12	<input type="checkbox"/> RR-6SU	<input type="checkbox"/> RR-4GT12	<input type="checkbox"/> RR-2GT24	<input type="checkbox"/> RR-GT36



Gas Type: Natural LP

Elevation (if above 2000 ft.): _____

Options and Accessories

- 6" high S/S stub back in lieu of high shelf
- 1" thick griddle plate
- Griddle on right (Left hand side standard)
- Chrome griddle plate
- Grooved griddle (specify width: _____")
- One thermostat per burner (GT Griddle Series)
- Convection Oven base - add suffix "-C"
- 12" hot top section - add suffix "-HT"
- 9" deep S/S front landing ledge, with or without sauce pan cutouts
- Additional oven racks
- Open storage cabinet base - add suffix "-XB"
- Cabinet doors
- Intermediate shelf
- Wok burner head with 10" diameter S/S ring
- 48" quick disconnect and restraining cable
- 5" swivel casters (set of four - 2 locking)

Standard Features

- Stainless steel drip tray/grease can
- Stainless steel front, sides, valve cover, and kick plate including backguard and high shelf
- Stainless Steel oven "U" burner rated at 35,000 BTU/hr
- Oven pilot with 100% safety shut down
- Two piece, heavy duty lift off cast iron burner heads rated at 30,000 BTU/hr
- 12" x 12" cast iron top grates with pilot shield
- Five position heavy gauge chrome rack guides
- One chrome rack per oven
- Five surface porcelain oven interior
- Stainless steel tubing for burners and pilots
- 3/4" thick polished steel griddle plate
- GT Griddle Series - standard with one thermostat per two burners
- SU - step up rear burners
- RG - raised griddle/broiler



Royal Range of California, Inc.

3245 Corridor Dr. • Eastvale, CA 91752 • (800) 769-2414 • (951) 360-1600

Fax: (951) 360-7500 • www.royalranges.com • sales@royalranges.com



36" Gas Restaurant Range

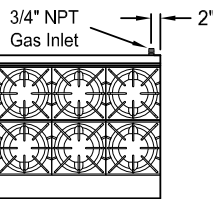
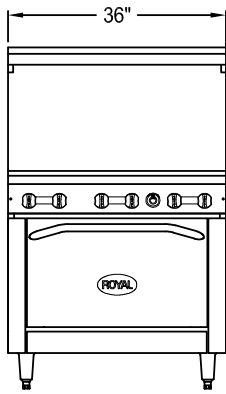

RR-6

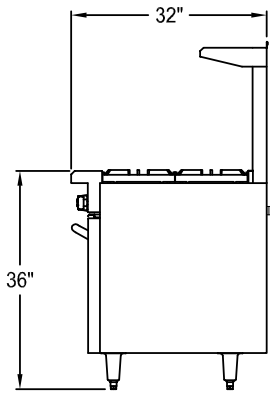

Standard Oven

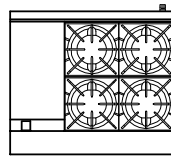

RR-4G12

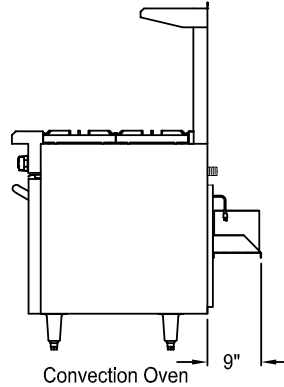

Convection Oven

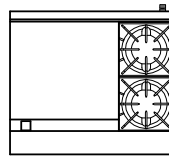

RR-2G24

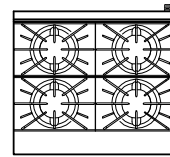

RR-4-36

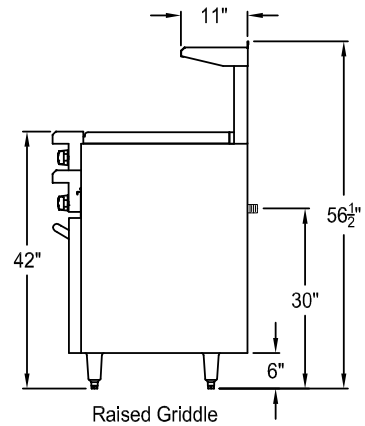

Raised Griddle

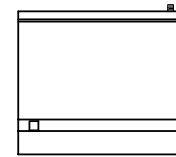

RR-G36

Model Number	Open Burners	Griddle Burners	Total BTU	Ship Weight
RR-6	6	0	215,000	600 lbs.
RR-4-36	4	0	155,000	580 lbs.
RR-2G(T)24	2	2	135,000	630 lbs.
RR-4G(T)12	4	1	175,000	620 lbs.
RR-G(T)36	0	3	95,000	650 lbs.
RR-4RG12	4	1	175,000	655 lbs.
RR-6SU	6	0	215,000	610 lbs.

Notes:

- For no oven (cabinet base) add suffix "-XB" and deduct 35,000 BTUs.
- For Convection Oven (30,000 BTU/hr) add suffix "-C" and deduct 5,000 BTUs.
- Open burners at 30,000 BTU/hr each.
- Griddle Burners: 1 per 12" at 20,000 BTU/hr each.
- Oven burner at 35,000 BTU/hr.

Gas Connection:

3/4" NPT on the right hand rear of the appliance.

The pressure regulator (supplied) is to be connected by the installer.

Electrical Requirements:

Convection Oven: 120 V, 50/60hz, 1 Ph., 8 amps

Two speed motor (1725/1140 RPM) 1/2 HP

Provided with 6' power cord fitted with a standard three prong grounded plug.

Gas Pressure:

5" W.C.	Natural Gas
10" W.C.	Propane

Clearances:

	Combustible	Non-Combustible
Rear	4"	0"
Sides	15"	0"

Specify type of gas and altitude, if over 2,000 feet, when ordering.

Due to continuing product development to ensure best possible performance, these specifications are subject to change without prior notification.

Royal Range of California, Inc.

3245 Corridor Dr. • Eastvale, CA 91752 • (800) 769-2414 • (951) 360-1600
 Fax: (951) 360-7500 • www.royalranges.com • sales@royalranges.com